



Servo-n

Startup guide



Contents

Contents	3
1 System overview.....	4
2 Alarms.....	18
3 Trends.....	26
4 NAVA and NIV NAVA	28
5 HFOV.....	30
6 Views.....	32
8 PRVC.....	40

Note

This guide is intended for healthcare professionals as start up training using the Servo-n ventilator. It does not cover all aspects of the Servo-n ventilator. Please see the user's manual for more information.

Some modes and functions are options and might not be included.

1 System overview



Behind the hatch are gas and electrical connections. The On/Off switch is placed to the left of the gas inlets.

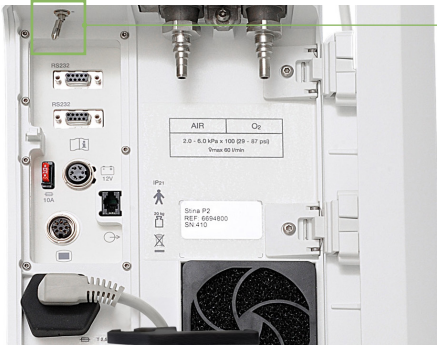

On/Off switch

Modules are interchangeable between Servo-n and u ventilator models. The Servo-n can host 2-6 battery modules and several

different plug-in modules. An alarm "Missing Battery" will be activated if less than 2 batteries are mounted.

The integrated nebulizer cable outlet

Y sensor module

Edi module



1. Expiratory outlet
2. AC mains power LED, blue
3. Power on LED, green
4. On/Off switch
5. RS-232 connectors
6. Fuse for external DC power
7. External +12V DC inlet
8. User interface control cable connector
9. AC mains power source connector with fuse
10. Potential equalization terminal
11. Alarm output connection
12. Cooling fan with filter
13. Lock for inspiratory channel cover
14. Gas inlet for air
15. Gas inlet for O₂
16. Inspiratory channel cover
17. Inspiratory outlet
18. Emergency air intake
19. Module compartment
20. Expiratory inlet
21. Nebulizer connector
22. Module release levers

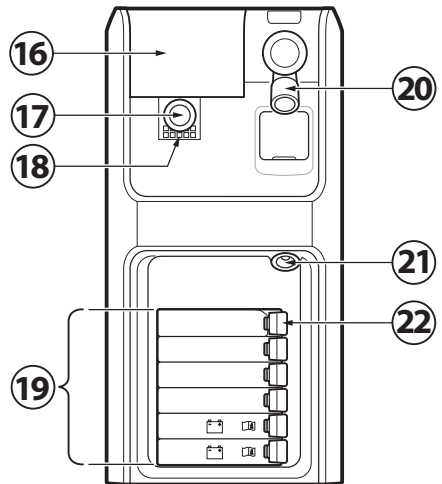
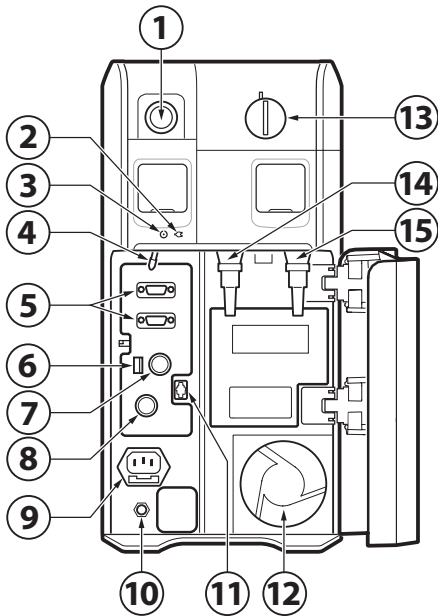

1. Alarm indicator, light frame
2. Ambient light sensor for automatic adjustment of screen brightness
3. Cable reel for the user interface control cable
4. Control cable (2.9 m and Option: 6 m)
5. User interface stand
6. Loudspeaker
7. Network cable port
8. User interface control cable port
9. VGA port
10. USB port
11. Serial number label

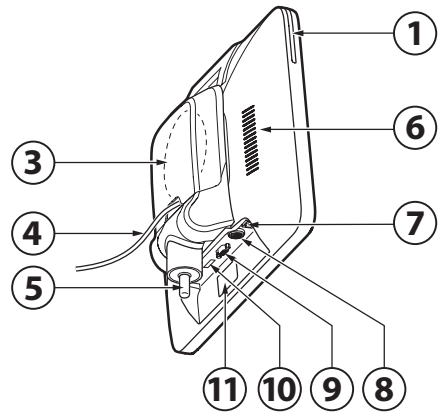
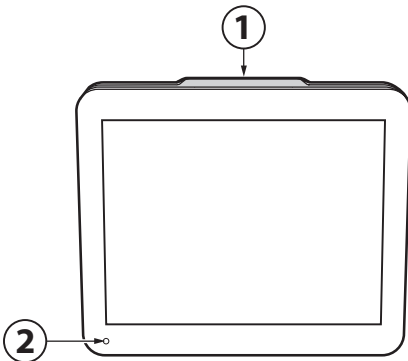

1.2 Workflow to start ventilation

1. Connect the ventilator to the mains power.
2. Connect pressurized O₂ and air tubes.
3. Connect the patient circuit and filter.
If active humidification add water to the water chamber.
4. Switch on power.
5. Perform a pre-use check.
6. Select patient category.
7. Select invasive or non-invasive ventilation.
8. Select ventilation mode and adjust settings.
9. Check and adjust alarm limits.
10. Start ventilation and connect ventilation system to patient.
11. Adjust alarm limits if necessary.



1.3 Pre-use check

The pre-use check takes approximately five minutes, is started from Standby view and is semi-automatic.

The patient circuit test measures resistance and compliance in the patient circuit. If the patient circuit is changed and no new patient circuit test is performed, the ventilator will compensate incorrectly with the

previous patient circuit. If it is not tested correctly e.g. with empty humidification chamber, the following risks may arise:

- In volume-based modes, the volume delivered to the patient will be incorrect.
- In pressure-based modes, the volume measured will be incorrect. →

The Patient circuit test is included in the pre-use check but can be left out and be performed later without affecting the pre-use test result.

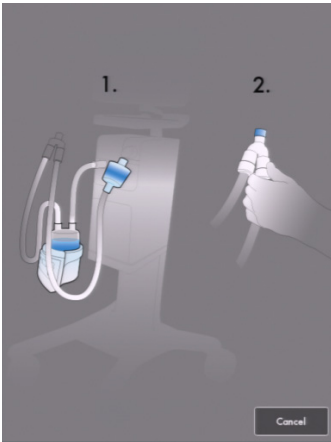

The symbol highlighted below indicates that the circuit compensation is on. If there has not been any circuit compensation, the symbol will not be present.



1.4 Modes and settings

There are two different patient categories, pediatric and neonatal.

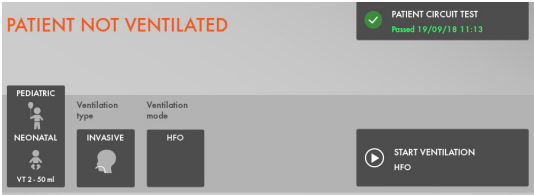

Select non-invasive ventilation or invasive ventilation.

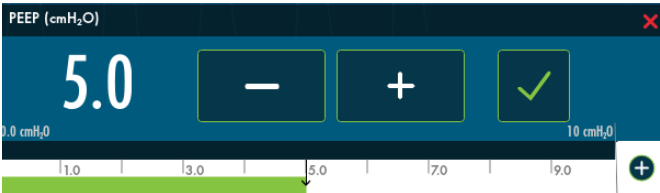
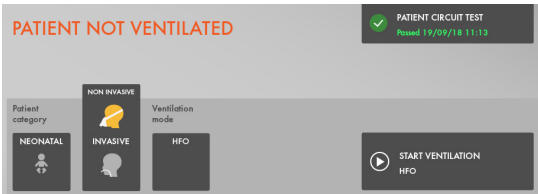

Slide the bar to the right or left to increase or decrease the settings. Confirm the setting by tapping ✓.

Exit settings without changing by tapping ✗.

The bar displays the safety scale, which is the range that represents normal use. To access the full settings range tap the ⊕.

To return to normal range tap the ⊖.

1.5 Modes

Tap to select mode. The current mode tile is always highlighted and the previous mode tile is marked "Previous mode", together with the date and time it was last used.

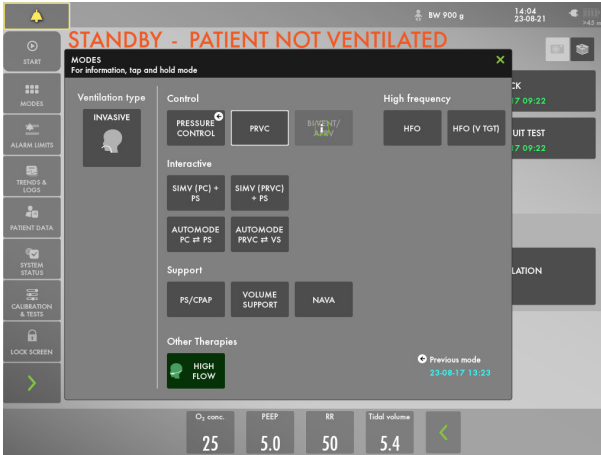

Note: High Flow therapy is available both in invasive modes and in non-invasive modes.

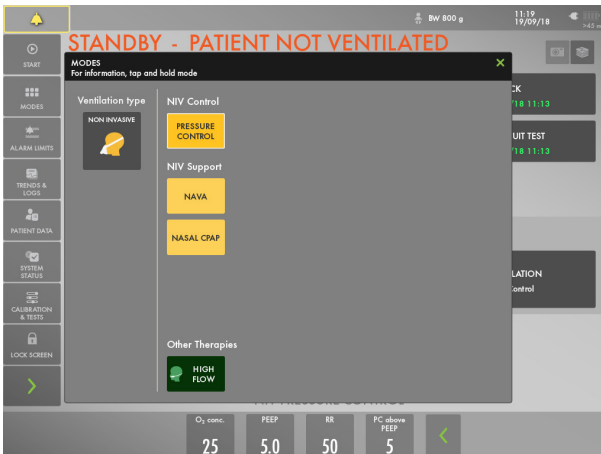

The mode settings are divided into supported and controlled settings.



1.5 Context based guidance

Tap and hold on the mode tile to see more information.

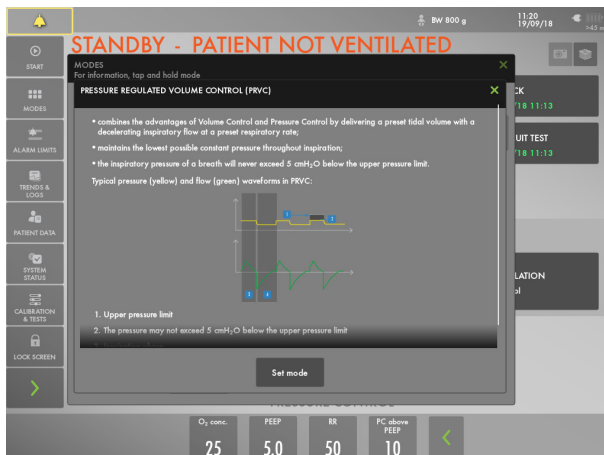

Dynamic images are presented for some of the settings. A dynamic image illustrates the effects of changes made.



Press the (i) symbol and additional information will be presented.



1.7 Trigger settings

When triggering is based on flow, left on the scale, the ventilator system senses deviations in the bias flow delivered during expiration. The further to the left on the scale, the less effort the patient has to make. At the far left of the scale, there is a risk of auto-triggering, and the scale and value are therefore marked in red.

When triggering is based on pressure, right on the scale, the ventilator system senses deviations in the pressure below PEEP created by the patient. The pressure below PEEP required to initiate a breath is displayed when the setting is made. The further to the right on the scale, the greater the patient effort required to trigger.



1.8 VT/KG

Enter patient weight and the ml/kg value value will be presented. It is important that patient circuit compensation is on to receive accurate VT/BW.



The ventilator monitors the ratio of tidal volume to patient weight (VT/BW). In volume controlled modes the VT/BW (ml/kg) is calculated and presented to the right of the volume.

VT/BW (ml/kg) is continuously trended and measured.

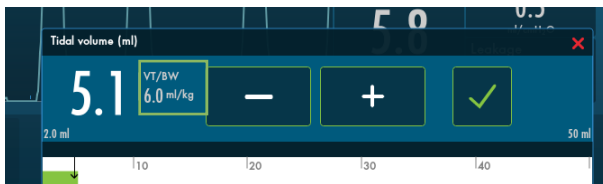

1.9 User interface



By pressing **>** additional values and settings become available.

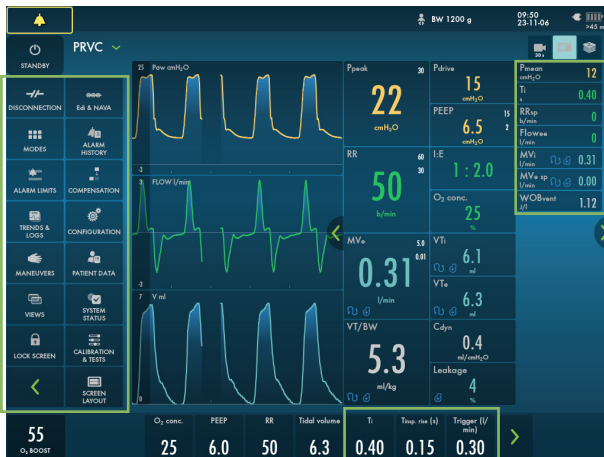

1.10 Active/inactive modes and settings

The grey text and settings indicate an inactive mode and settings. If a mode is changed then the other mode becomes white.

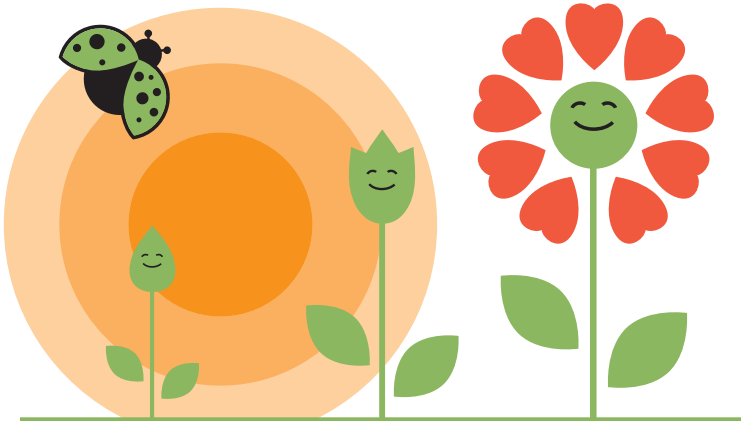

2 Alarms

Light frame for 360° visibility. Alarm indication is shown in two ways; blinking value (measured or calculated) and alarm message in the alarm message area.

- High priority
- Medium priority
- Low priority

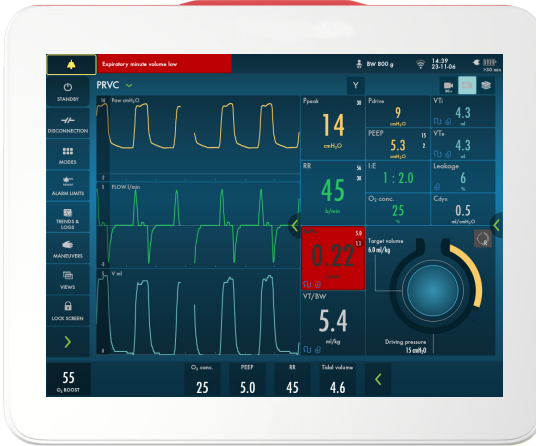

With some alarms the audio can be turned off by tapping . Audio off is displayed in the corresponding parameter in the

numerical values area and a message is displayed in the status bar.



- Inspiratory tidal volume too high
Settings for alarm limits include upper and lower limits settings and the

current measured value.
Autoset alarm limits are available in controlled modes.

Upper alarm limit

Current measured value

Lower alarm limit

Alarm sound level setting

The following alarms can be turned off in invasive ventilation when leakage compensation is active:

- Leakage too high.
- Expiratory minute volume low
- Expiratory minute volume high



Two alarms active

Alarm management checklist

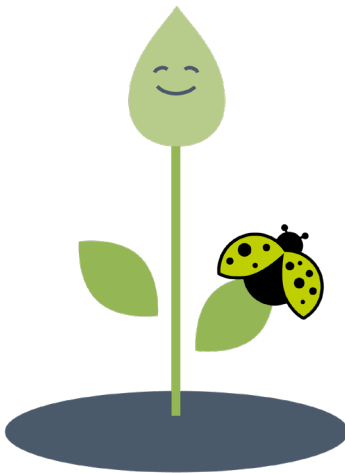

2.1 Batteries

If the ventilator system is running on battery power, the battery symbol turns yellow and the mains power symbol disappears. The

estimated remaining battery time in minutes is always displayed, regardless of the power supply in use.

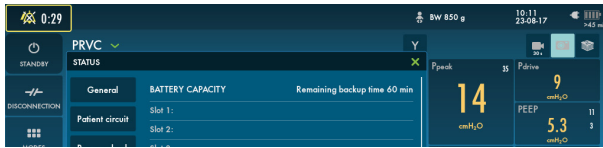

Battery time remaining

2.2 Maneuvers

Open Lung Tool provides a breath-by-breath presentation of measured ventilatory values, lung mechanics and gas exchange. OLT Trends can be used to see the develop-

ment of the lung mechanical status. In Pediatric patient category the Auto RM - an automatic recruitment maneuver - can be used.



When the MANUAL BREATH is tapped, the ventilator system will initiate a new breath cycle according to the current ventilator settings.

2.3 Static measurements



2.4 Inspiratory hold

This function is activated by pressing INSPIRATORY HOLD. This function can provide an exact measurement of the end inspiratory lung pressure.

2.5 Expiratory hold

Expiratory and inspiratory valves are closed after the expiration phase is completed for as long as EXPIRATORY HOLD is pressed.

2.6 Nebulization

Nebulization can be either activated for a certain period of time (5–30 minutes) or continuous (only use Aerogen Solo).



2.7 O₂ boost

When tapping and holding, O₂ boost delivers the oxygen setting displayed here for a period of 1 minute. The O₂ boost function can be interrupted by tapping the red cancel symbol in the O₂ boost timer window anytime during the 1 minute interval.

Alarms are turned off for one minute when the O₂ boost has been activated.

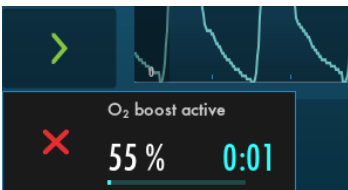

2.8 O₂ boost level

By tapping O₂ BOOST LEVEL, it is possible to change the desired level for the O₂ boost function. It is possible to lock the O₂ boost level to 100 %. The value entered under O₂ boost (%) level specifies the number of percentage points that will be added to the value set for the O₂ concentration.

For example: if the current O₂ concentration is 40 % and the O₂ boost level is 30 %, the O₂ boost function will, when tapped, deliver 70 % O₂. The O₂ boost function figure displayed will change accordingly.



It is also possible to set it to 0 %, in which case the O₂ boost function will no longer be active and will be replaced by three asterisks.

2.9 Disconnection

Disconnection enables automatic inhibition of the ventilator system during a tracheal suction procedure or when briefly pausing ventilation in invasive modes. The ventilator system is prevented from cycling without activating alarms.

When using a closed-suction system, Disconnection should not be used. The O₂ boost function should be used instead for oxygenation purposes.



Important

Use Disconnection for all disconnections of the patient circuit when ventilating in NAVA or in the neonatal patient category when leakage compensation is active.

3 Trends

Trend values are stored every 60 seconds and retained for a maximum of 72 hours. Stored events and system changes are also displayed here.

The time valid for the cursor position is displayed. If events have been stored, their number is displayed in the ring shown in the

figure and an explanation appears to the left of this ring.



Tap Organize trends to place the trends in the desired order by dragging and dropping the different trended values presented.



By default the short trends show the last 15 minutes but can show a maximum of 72 hours.

Tap the arrow to open the short trends.

The backup is trended, which provides an indication of apneas

- Backup time %/min
- Backup frequency/min



If the number of switches to backup/min is high and the neonate is stable, the current apnea time may be too short and the neonate could tolerate a longer apnea time. If number of switches to backup/min is high and the neonate is desaturating, the current apnea time (time without any ventilation) may be too long, consider shortening the apnea time. If number of switches to backup/min is low, the neonate is having minimal apnea at the set apnea time, consider lengthening the apnea time.

Percent (%) of time in backup ventilation/min

- This indicates the amount of time (as a %) the neonate is in backup/min. If % of time in backup ventilation/min is high and the number of switches to backup/min are low then the neonate may not be ready to be weaned (the neonate is mostly in backup). If % of time in backup ventilation/min is low the neonate may be ready to be weaned by lengthening the apnea time. If both the % time in backup is high and the number of switches to backup/min is high the neonate may be ready to be weaned by lengthening the apnea time.

4 NAVA and NIV NAVA

The NAVA is and NIV NAVA workflows facilitate the set-up and use of these modes.



In the verticle field both the symbols on the representation of the Edi catheter and the color highlights on the leads show where the Edi signal is strongest.

If no Edi signal is detected, there will be no such indications. Note that the color highlights on the leads change more rapidly than the symbols on the Edi catheter.





4.1 Edi monitoring

It is possible to use the Edi monitoring even when the patient is not ventilated. It is possible to go directly from running mode to Edi monitoring if the edi catheter is connected.

The Edi signal is trended, with up to 72 hours of trends available and up to 12 hours available from the Edi monitoring window. In High Flow therapy it is possible to monitor the Edi signal.



5 HFOV

HFOV is available in pressure control (HFO) and volume target (HFO (V TGT)) modes. The Y sensor and the pressure line must be

connected during HFOV, since it enables measurement of volumes and mean pressure at the Y piece.



In HFO (V TGT) if the Y sensor is disconnected or inactive (e.g. due to condensate), the ventilator system will automatically switch to backup ventilation (HFO).

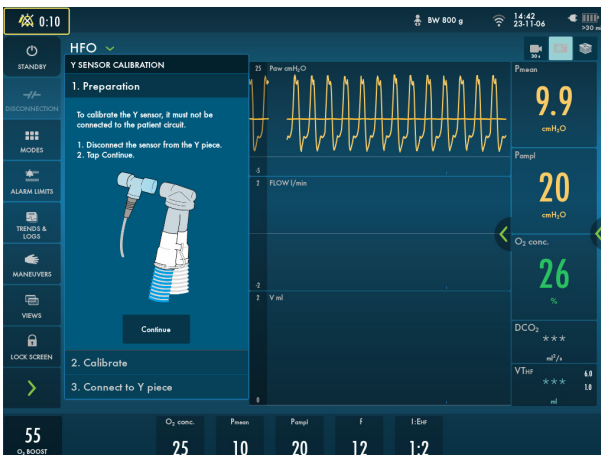

In HFO (V TGT) the volume is set. Note that ml/kg is displayed here.

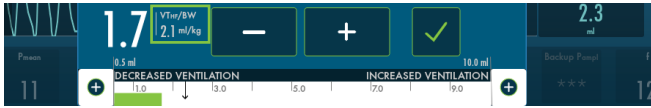

PAUSE OSCILLATION maneuver pauses the oscillation but maintains the Pmean (available in HFOV modes).



6 Views

The ventilator system offers different views to suit different needs. They are accessed via the quick menu during ventilation.



5.1 Basic view

The view consists of two or three waveforms – pressure and flow waveforms are always present, together with the volume waveform if desired.

The Basic view is not available if an Edi or CO₂ module is connected non-invasive ventilation modes except NIV NAVA start in the Basic view.



6.2 Advanced view

The view consists of two to five waveforms. Pressure and flow waveforms are always present, together with the volume waveform

if desired and the Edi and CO₂ waveforms, if available are presented in two columns of numerical values.



6.3 Loop view

The view consists of up to three loops:

- pressure-flow
- pressure-volume
- volume-flow



6.4 Compass view

Servo Compass visualizes volume and pressure in relation to set targets in invasive modes.

If the driving pressure or total pressure exceeds the pressure limit, the pressure limit animation will change color.



6.5 Distance view

There are six large tiles displaying:

- Five enlarged numerical values
- The pressure and flow waveforms, as well as the Edi waveform, if available.



6.6 Family view

Displayed information is minimized to:

- One column of numerical values.
- Alarms and messages in the status bar.
- The direct access settings bar.

– A dynamic image (moving bubbles) shows that ventilation is in progress.

To exit the family view you can tap anywhere on the screen.



6.7 Screen layout

The ventilator system can display a minimum of two waveforms and a maximum of five, depending on the view selected.

Pressure and flow waveforms are always mandatory except in the FAMILY view.

(Note: In Nasal CPAP, only pressure and flow waveforms are available). The easiest access to screen layout is to tap and hold the waveform.



Choose filled or non-filled waveforms

Servo Compass can be added or removed on the screen.

6.7 Panel lock

Possible to lock the screen for example for cleaning. Tap and hold to unlock.



6.8 High Flow therapy

High flow therapy can be selected in both invasive and non-invasive ventilation as well as in Standby.

Possibility to switch directly from invasive ventilation.

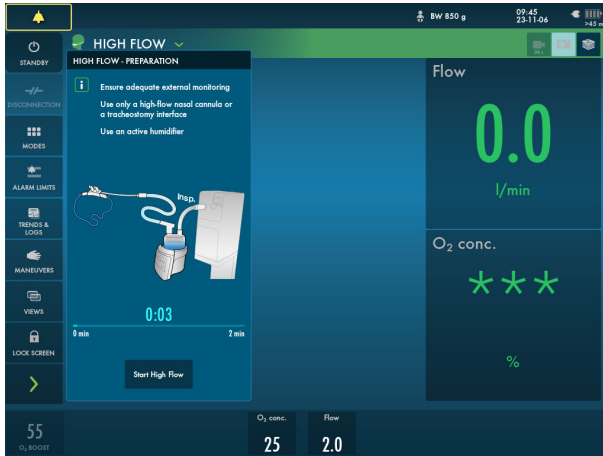

Edi monitoring is available during High Flow therapy.



6.9 Nasal CPAP

The Servo-n Nasal CPAP maintains a set continuous positive airway pressure via a non invasive nasal patient interface and gives the flow necessary to maintain the pressure set. The pressure is stable even at higher leakages.

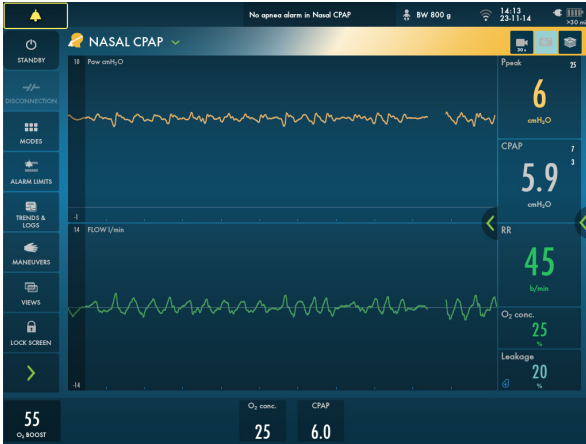

The CPAP alarm sound can be switched off.

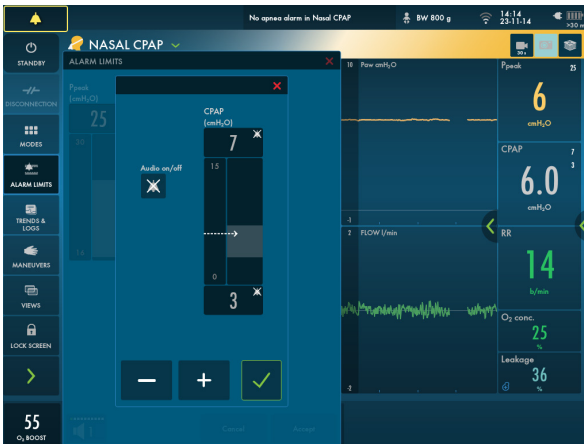

7.0 Library



7.1 Recording

A 30 second long recording will be made starting 15 seconds before, and lasting until 15 seconds after the time the recording was initiated.

The recording will be stamped with the date and time that it was initiated and will be saved under the Recordings tab in the library. Forty recordings can be saved on the Servo-n.

7.2 Screenshots

The screenshot will be stamped with the date and time it was taken and saved under the Saved screens tab in the Library window.

Forty screenshots can be saved.

All screenshots and recordings can be transferred to a USB memory stick. The USB port is under the user interface.



8 PRVC

Pressure Regulated Volume Control (PRVC) is a volume-targeted mode that automatically calculates and regulates the pressure needed to deliver the preset tidal volume.

Separated regulation of controlled and assisted breaths reduces tidal volume swings and ensures low driving pressure, even when the patient starts to trigger.

For neonatal patient category, activated leakage compensation ensures volume delivery at the level set.



Servo-n has real volume guarantee in PRVC and VS, the leakage loss is added to inspiratory volume.

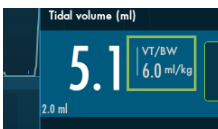

8.1 Invasive leakage compensation

Invasive leakage compensation is available in the neonatal patient category to compensate for the leakage around uncuffed endotracheal tubes.

Compensated values in the user interface will show the symbol  for leakage compensation.

Leakage compensation maintains PEEP, compensates for trigger sensitivity, end inspiration and measured values, as well as adding volume in PRVC and VS to reach targeted tidal volume.



8.2 Volume restriction

For the neonatal patient category, the ventilator system has a volume restriction. This means that the alarm limit set for VTi restricts volume delivery, so that a higher

volume than set by this limit will not be delivered. This applies in: PC, PS, Automode, PC-PS and all SIMV modes.



8.3 Y sensor and pressure line

For tidal volumes below 5 ml, it is recommended to use a Y sensor to increase the accuracy of gas delivery and monitoring.

For HFOV modes the Y sensor and the pressure line is needed.

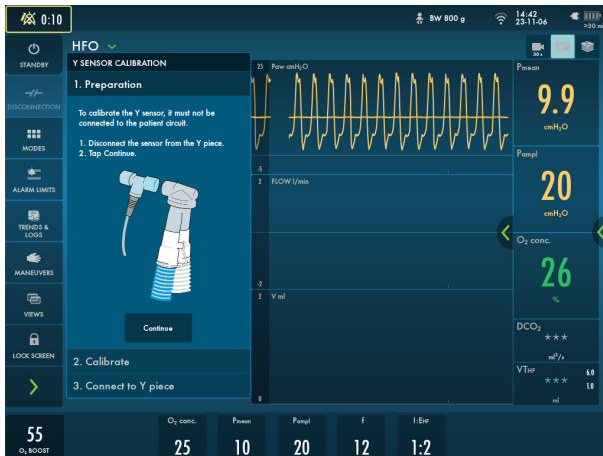

When the Y sensor is active, the flow through the sensor will replace the bias flow as source for flow based triggering.

To interrupt the Y sensor measuring, disconnect the Y sensor module.

To guarantee that waveforms and measured values are always displayed on the screen, the internal pressure and flow sensors are at all times active as backup. Their readings are compared with the Y sensor measurement. The Y sensor is disabled if there is a significant deviation or malfunction.

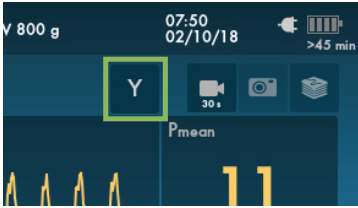

Note: The pressure line is only needed during HFOV modes. In other modes the pressure line is not needed.



This document is intended to provide information to an international audience outside of the US. Servo-n may be pending regulatory approvals to be marketed in your country. Contact your Getinge representative for more information.

Getinge is a global provider of innovative solutions for operating rooms, intensive care units, sterilization departments and for life science companies and institutions. Based on our firsthand experience and close partnerships with clinical experts, healthcare professionals and medtech specialists, we are improving the everyday life for people, today and tomorrow.

Manufacturer · Maquet Critical Care AB · Röntgenvägen 2 SE-171 54 Solna · Sweden · +46 (0)10 335 73 00

www.getinge.com