



Maquet Magnus Operating Table System

Streamline your operating room processes

This document is intended to provide information to an international audience outside of the US.

GETINGE 

A close-up, low-angle shot of a medical table in an operating room. The table is primarily silver with black padding and accents. A white label with the brand name and logo is visible on the side. The background shows the curved overhead structure of the operating room, including surgical lights and other equipment, all in a clean, clinical setting.

GETINGE ✱

Streamlining workflows

– enhancing patient safety

The Maquet Magnus Operating Table System is the culmination of Getinge's knowledge, resources and expertise, providing state-of-the-art technology for optimized workflows and improved patient safety in the OR.

Getinge is built on a genuine compassion for people's health, safety, and wellbeing. Founded in 1904 with roots dating back to 1838, Getinge has grown organically and through acquisitions to become a global market leader. Our product portfolio offers solutions and support throughout the clinical pathway and features many well-known and dependable product brands – including the Getinge OR Table Systems,

which were first developed more than 50 years ago. The Getinge Table System Maquet Magnus sets standards in extreme positioning and stability through its impressive flexibility and weight-bearing capacity. At the same time, the ergonomic design and safety features ensure a healthy and comfortable environment for patients and surgical teams.



Maquet Magnus Operating Table System

Explore the possibilities

The Maquet Magnus OR Table System has been specifically designed to optimize workflows in the operating room and create a safe and healthy space for surgical staff and patients. But it also comes with great maintenance service to keep your OR up and running. As your full-service partner, Getinge is at your side every step of the way, working together as one. Fast response times by certified technicians help minimize disruptions in your hospital's patient turnaround and keep your operations working smoothly.



Its extreme height adjustment and patient positioning capabilities are what sets Maquet Magnus apart from other operating table systems. It is based on modules, making it highly versatile, user-friendly and easy to maintain. It is thus a future-proof investment, as you can simply exchange or add components, depending on your hospital's needs. Easy Click interfaces, effortlessly removable table tops and intuitive features all reduce the probability of user errors.



Collisions in the OR are one of the major risks to staff and equipment, and potentially time-consuming during surgery. By tracking specially designed transponders in the equipment, **the Maquet Magnus OR Table System can detect collisions before they happen** and issue a warning if accessories are on a collision course with the column or floor. Its intelligent power management system features an automatic standby-by mode to reduce power consumption and is so efficient that the table needs charging only once a week. This increased reliability along with a better product lifetime and protection for your hospital's investment mean peace of mind for you.



In addition to the modular universal table top, **the Maquet Magnus product range also includes carbon fiber table tops, which are ideally suited to the Hybrid OR.** Hybrid ORs are surgical workspaces that combine imaging equipment with a multifunctional surgical table. They allow clinicians to diagnose and treat in a single location, reducing risk and delays, improving patient safety, and ultimately reducing costs.



Biomedical technicians are tasked with taking care of many products in the hospital environment, so they need reliable equipment with minimal maintenance requirements.

Hybrid ORs – surpassing today's expectations

Image-guided surgery will become the new standard

At the core of the Getinge Hybrid OR is the Maquet Magnus Operating Table System

Featuring interchangeable carbon fiber and universal table tops, Maquet Magnus can be quickly configured to accommodate a range of image-guided surgical procedures. Designed to work in full harmony with leading imaging system suppliers, Maquet Magnus is key to making the Hybrid OR future proof, offering integrated solutions for angiography systems, CT and MRI, that ensure superior imaging and table performance.

The precise and controlled table movements protect patients and improve accuracy during intra-operative readjustments. Quickly interchangeable radiolucent table tops allow for seamless transition between surgical procedures and disciplines. At the same time, they improve patient outcomes by reducing the need to transport the patient between multiple departments and teams.

The Maquet Magnus product range also includes carbon fiber table tops, which are ideally suited to the Hybrid OR. These plates are made of radiolucent carbon fiber composite material, which allows a 360° imaging without metal elements that could influence the image. Available interfaces to common imaging partners offer perfect synchronization with imaging equipment. Synchronized movements of X-ray equipment and Maquet Magnus improve radiological results due to the retention of the isocentre.

Even in time-critical situations, Maquet Magnus gives you the freedom you need to make the best possible decisions for your patients.



GETINGE *

GETINGE *
MAQUET | MAGNUS

Peace of mind

– that follows you all the way

A Getinge Care service agreement maximizes the long-term value of your investment. Your Getinge products will be monitored and maintained to ensure that they deliver peak performance whenever and wherever they are needed.

You are our priority

Maximizing equipment performance should not need to strain your budget. Our four levels of service packages are designed with your hospital's success in mind. Whether you have a full service department on site, or limited in-house personnel, we can meet your needs.

Our Getinge-certified field service representatives and Getinge original parts are your best investment in maximizing the life span of your equipment.

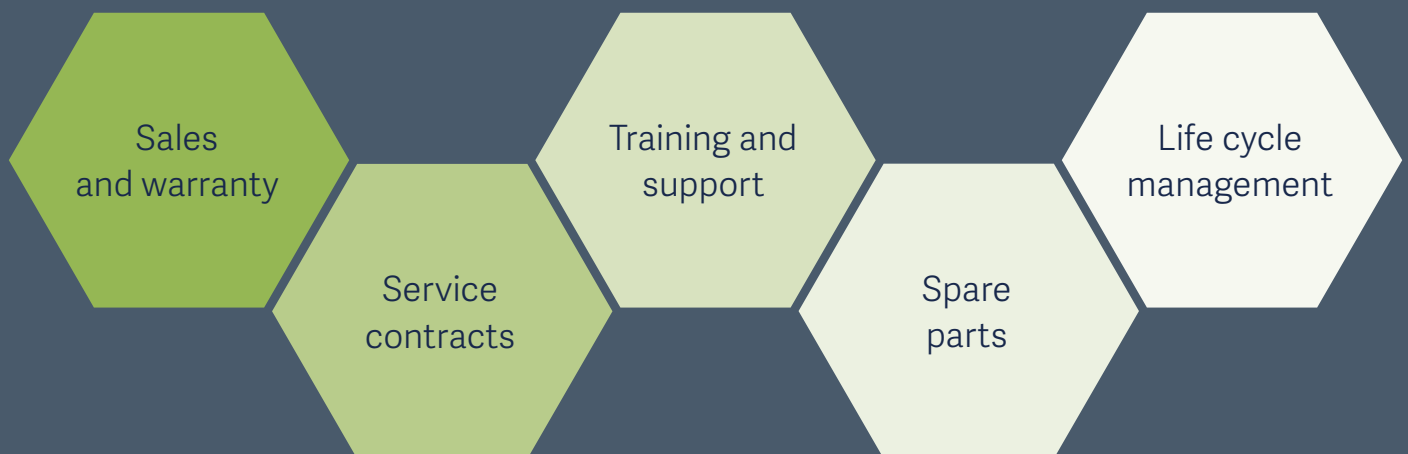

The name Getinge Care was carefully chosen to reflect our commitment to providing for your needs, so you can care for your patients.

Technical description

and construction features

Maquet Magnus OR Table column

- OR table column for mounting system-compatible operating table tops
- Adaptive transfer: the table column automatically recognizes the transfer position and guides the column head accordingly
- Electro-hydraulically driven column
- Transfer of the operating table tops from both sides and with free selection of orientation of head or foot first. Automatic recognition of orientation direction of the operating table top on the column and corresponding allocation of the functional keys on the control units
- Horizontal alignment of the column head (post-operative), either by activating the zero position function through the hand-held controller or by positioning the transporter and activating the "Height up/down" column function
- Activation of the motorized movements of the OR table system using the infrared hand-held controller, cabled hand-held controller or foot lever as well as through the additional operating panel, which is integrated in the OR table column
- Two splash-protected plug-type connections for the parallel connection of cabled hand-held controller and foot lever
- Column casing made of stainless steel

Available in four versions

1180.01A0 – Stationary version for installation into built-in base plate 1120.98A0 or 1150.98A0

- Liquid-tight installation, flush with upper edge of finished floor; can be rotated through approx. 350°; can be locked in any position
- Power supply to the operating table column through stationary transformer unit with battery buffer

1180.01B0 – Stationary column with floor mounting plate for installation on finished floor

- Power supply, same as 1180.01A0

1180.01C0 – Mobile column, can be moved with transporter

- Power supply for the operating table column through maintenance-free batteries, integrated into the base plate; operating capacity between two charging cycles, approx. one OR week
- Batteries are recharged and OR table column is operated through a mains supply, using a mobile transformer unit, which is included in the scope of delivery

1180.01D0 – Independently manoeuvrable column, can be moved using the integrated castors and activated by the hydraulic pedal-operated pump

- Power supply, same as 1180.01C0

Maquet Magnus OR Table Tops

- OR table top as symmetrically divided basic unit, with identical interfaces on both sides, allowing for individual configuration, depending on surgical requirements
- Plug-in modules may be selected as required
- Table top has radioscapy window between the bars without crossbars, for intra-operative use of image intensifier
- OR table top frame and side rails (10 x 25 mm) made of stainless steel
- Radiolucent, 80 mm thick hybrid cushioning, with electrical discharging capacity. The support plates can easily be removed for cleaning, without tools
- The central cushioning segment in a sandwich design, including wear-protection with visco-elastic foam and bi-elastic cover, offers excellent pressure distribution and reduces shearing forces
- Electro-powered drive of the OR table top provides longitudinal shift (free-positioning for radiosopic examination with C-arm), as well as "Back plate up / down" and "Leg plates up / down"
- Return to the last stored patient position following C-arm control in modified patient position, using the hand-held controller
- OR table top can be adjusted using plug-in modules (see below) for various specialist surgical disciplines or different patient body sizes. Mounting points for easy, safe adaptation of modules such as:
 - Motorised joint module 1180.11A0/B0
 - Standard back plate 1180.31A0 for general surgery
 - Extension plate 1180.32A0
 - Transfer board as leg support for the initial phase in dorsosacral position 1180.57A0
 - Leg plates, divided into four, can be bent, spread and raised for genucubital position 1180.54A0
 - Shoulder module 1180.34A0
 - Carbon-fiber plate 1180.45A0
 - Extension plug-in device 1180.19A0
 - Dual-joint head rest 1180.53A0
 - Single-joint head rest 1180.50A0
- Very easy adaptation is ensured using a snap connector (Easy Click System). Device is immediately held in place to prevent accidental loosening

Technical specifications

Length of universal table top Head-side configuration with one joint pair, back plate, extension plate and head rest	1,945 mm
--	----------

Length of universal table top Leg-side configuration with one joint pair, head rest and leg plates	2,055 mm
--	----------

Width of universal table top	540 mm
------------------------------	--------

Width across side rails	580 mm
-------------------------	--------

Radioscapy window between the bars	410 mm
------------------------------------	--------

Motorized adjustments

Height (without cushioning)	
Stationary column	535–1,240 mm
Mobile columns	565–1,270 mm

Inclination: head down / foot down	80° / 80°
---	-----------

Tilt, left / right	45° / 45°
--------------------	-----------

Longitudinal shift	460 mm
--------------------	--------

Back plates up / down	+90° / -60°
-----------------------	-------------

Leg plates up / down	+80° / -90°
----------------------	-------------

Max. patient weight incl. accessories

Built-in base plate column 1180.01A0	380 kg
Surface-mounted base plate column 1180.01B0	380 kg
Mobile column 1180.01C0	380 kg
Mobile column 1180.01D0	250 kg

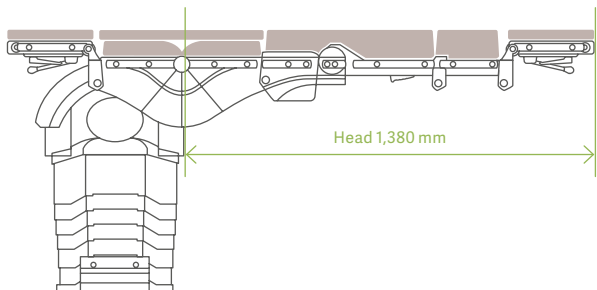

Radioscopy access with positioning in head direction

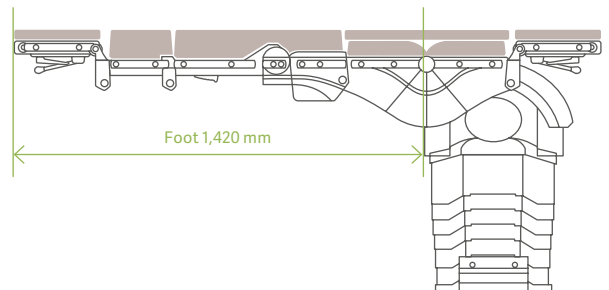

Radioscopy access with positioning in foot direction

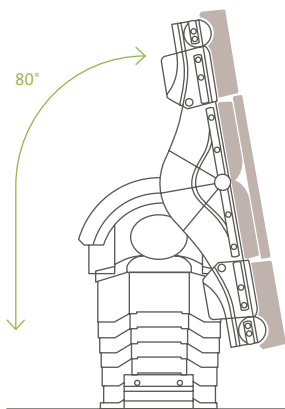

Foot down/head down tilt, max. 80°

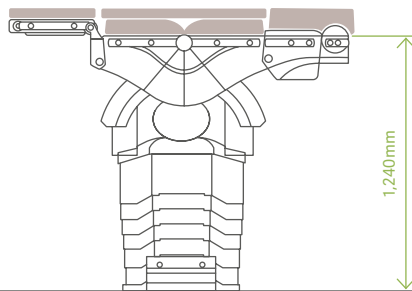

Highest position without cushioning

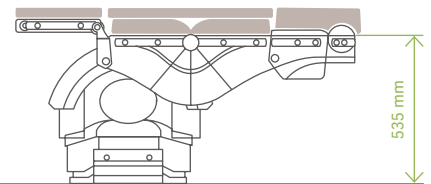

Lowest position without cushioning

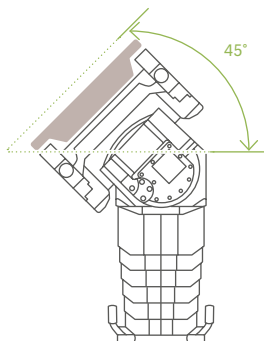

Left/right tilt: max. 45°

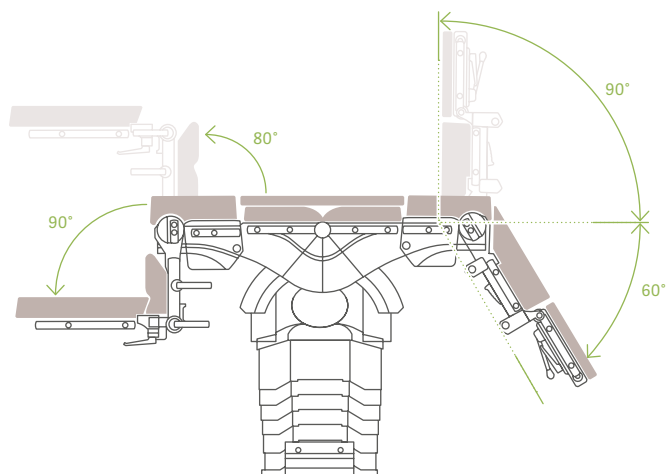

Back plate position: up/down +90°/-60°,
 Leg plate position: up/down +80°/-90°,
 Lower leg plate: up/down +90°/-90°



Getinge is a global provider of innovative solutions for operating rooms, intensive care units, sterilization departments and for life science companies and institutions. Based on our firsthand experience and close partnerships with clinical experts, healthcare professionals and medtech specialists, we are improving the everyday life for people – today and tomorrow.

This document is intended to provide information to an international audience outside of the US.

Maquet GmbH · Kehler Str. 31 · 76437 Rastatt · Germany · +49 7222 932-0

www.getinge.com